

FULLY PROTECTED POWER MOSFET SWITCH

Features

- Over temperature shutdown
- Over current shutdown
- Active clamp
- Low current & logic level input
- E.S.D protection

Description

The IPS041L is a fully protected three terminal SMART POWER MOSFET that features over-current, over-temperature, ESD protection and drain to source active clamp. This device combines a HEXFET® POWER MOSFET and a gate driver. It offers full protection and high reliability required in harsh environments. The driver allows short switching times and provides efficient protection by turning OFF the power MOSFET when the temperature exceeds 165°C or when the Drain current reaches 2A. The device restarts once the input is cycled. The avalanche capability is significantly enhanced by the active clamp and covers most inductive load demagnetizations.

Product Summary

| | |
|------------------|---------------------|
| $R_{ds(on)}$ | 500m Ω (max) |
| V_{clamp} | 50V |
| $I_{shutdown}$ | 2A |
| T_{on}/T_{off} | 1.5 μ s |

Package

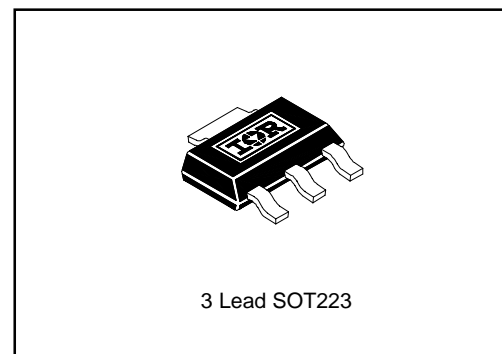

Typical Connection

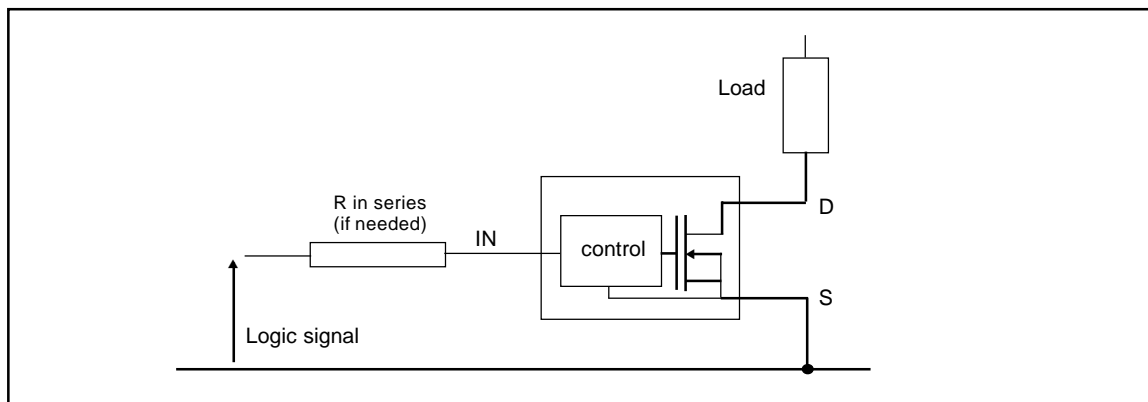

Absolute Maximum Ratings

Absolute maximum ratings indicates sustained limits beyond which damage to the device may occur. All voltage parameters are referenced to SOURCE lead. (T_{Ambient} = 25°C unless otherwise specified). PCB mounting uses the standard footprint with 70 μm copper thickness.

| Symbol | Parameter | Min. | Max. | Units | Test Conditions |
|------------------------|--|------|------|-------|-----------------------|
| V _{ds} | Maximum drain to source voltage | — | 47 | V | |
| V _{in} | Maximum input voltage | -0.3 | 7 | | |
| I _{in, max} | Maximum IN current | -10 | +10 | mA | |
| I _{sd cont.} | Diode max. continuous current ⁽¹⁾ (r _{th} =125°C/W) | — | 1.2 | A | |
| I _{sd pulsed} | Diode max. pulsed current ⁽¹⁾ | — | 3 | | |
| P _d | Maximum power dissipation ⁽¹⁾ (r _{th} =125°C/W) | — | 1 | W | |
| ESD1 | Electrostatic discharge voltage (Human Body) | — | 4 | kV | C=100pF, R=1500Ω, |
| ESD2 | Electrostatic discharge voltage (Machine Model) | — | 0.5 | | C=200pF, R=0Ω, L=10μH |
| T _{j max.} | Max. storage & operating junction temp. | -40 | +150 | °C | |

Thermal Characteristics

| Symbol | Parameter | Min. | Typ. | Max. | Units | Test Conditions |
|------------------|---|------|------|------|-------|-----------------|
| R _{th1} | Thermal resistance with standard footprint | — | 100 | — | °C/W | |
| R _{th2} | Thermal resistance with 1" square footprint | — | 60 | — | | |

Recommended Operating Conditions

These values are given for a quick design. For operation outside these conditions, please consult the application notes.

| Symbol | Parameter | Min. | Max. | Units |
|---|---|------|------|-------|
| V _{ds (max)} | Continuous drain to source voltage | — | 35 | V |
| V _{IH} | High level input voltage | 4 | 6 | |
| V _{IL} | Low level input voltage | 0 | 0.5 | |
| I _{ds} T _{amb} =85°C | Continuous drain current (T _{Ambient} = 85°C, I _N = 5V, r _{th} = 100°C/W, T _j = 125°C) | — | 0.75 | A |
| R _{in} | Recommended resistor in series with IN pin | 1 | 5 | kΩ |
| T _{r-in(max)} | Max recommended rise time for IN signal (see fig. 2) | — | 1 | μS |
| F _{r-lsc} ⁽²⁾ | Max. frequency in short circuit condition (V _{cc} = 14V) | 0 | 1 | kHz |

(1) Limited by junction temperature (pulsed current limited also by internal wiring)

(2) Operations at higher switching frequencies is possible. See Appl. notes.

Static Electrical Characteristics

(T_j = 25°C unless otherwise specified.)

| Symbol | Parameter | Min. | Typ. | Max. | Units | Test Conditions | |
|--|---------------------------------|------------------------|------|------|-------|---|--|
| R _{ds(on)} | ON state resistance | T _j = 25°C | — | 370 | 500 | mΩ | V _{in} = 5V, I _{ds} = 1A |
| | | T _j = 150°C | — | 590 | 900 | | |
| I _{dss1} @T _j =25°C | Drain to source leakage current | 0 | 0.5 | 25 | μA | V _{CC} = 14V, T _j = 25°C | |
| I _{dss2} @T _j =25°C | Drain to source leakage current | 0 | 5 | 50 | | V _{CC} = 40V, T _j = 25°C | |
| V _{clamp 1} | Drain to Source clamp voltage 1 | 47 | 52 | 56 | V | I _d = 20mA (see Fig.3 & 4) | |
| V _{clamp 2} | Drain to Source clamp voltage 2 | 50 | 53 | 60 | | I _d =I _{shutdown} (see Fig.3 & 4) | |
| V _{in clamp} | IN to Source clamp voltage | 7 | 8.1 | 9.5 | | I _{in} = 1 mA | |
| V _{in th} | IN threshold voltage | 1 | 1.6 | 2 | | I _d = 50mA, V _{ds} = 14V | |
| I _{in, -on} | ON state IN positive current | 25 | 90 | 200 | μA | V _{in} = 5V | |
| I _{in, -off} | OFF state IN positive current | 50 | 130 | 250 | | V _{in} = 5V over-current triggered | |

Switching Electrical Characteristics

V_{CC} = 14V, Resistive Load = 20Ω, R_{input} = 1kΩ, 100μs pulse, T_j = 25°C, (unless otherwise specified).

| Symbol | Parameter | Min. | Typ. | Max. | Units | Test Conditions |
|------------------|--|------|------|------|-------|----------------------|
| T _{on} | Turn-on delay time | 0.05 | 0.2 | 0.5 | μs | See figure 2 |
| T _r | Rise time | 0.5 | 1.3 | 2.5 | | |
| T _{rf} | Time to 130% final R _{ds(on)} | — | 5 | — | | |
| T _{off} | Turn-off delay time | 0.5 | 1.6 | 2.5 | | See figure 2 |
| T _f | Fall time | 0.5 | 1.5 | 2.5 | | |
| Q _{in} | Total gate charge | — | 1 | — | nC | V _{in} = 5V |

Protection Characteristics

| Symbol | Parameter | Min. | Typ. | Max. | Units | Test Conditions |
|--------------------|---|------|------|------|-------|---|
| T _{sd} | Over temperature threshold | — | 165 | — | °C | See fig. 1 |
| I _{sd} | Over current threshold | 1.1 | 1.7 | 2.2 | A | See fig. 1 |
| V _{reset} | IN protection reset threshold | 1.5 | 2.3 | 3 | V | |
| T _{reset} | Time to reset protection | 2 | 10 | 40 | μs | V _{in} = 0V, T _j = 25°C |
| EOI_OT | Short circuit energy (see application note) | — | 400 | — | μJ | V _{CC} = 14V |

IPS041L

Functional Block Diagram

All values are typical

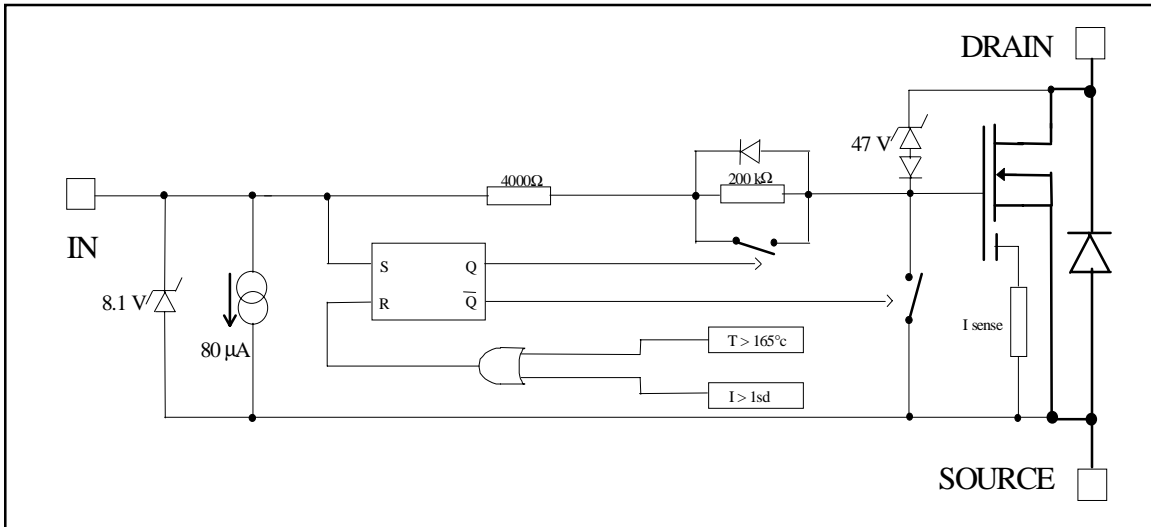

Lead Assignments

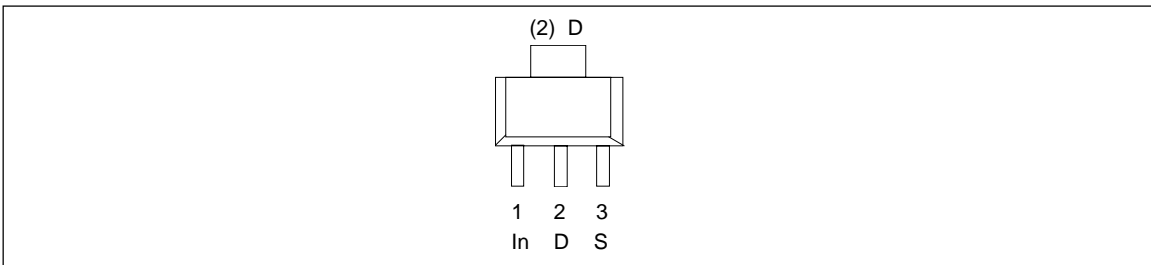

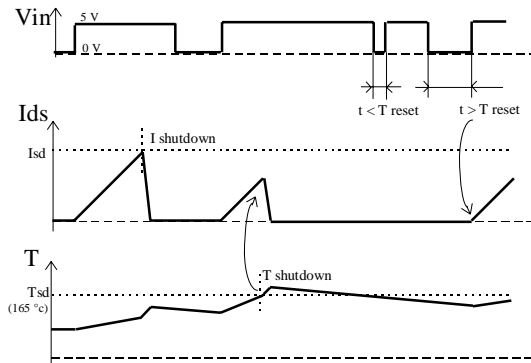

Figure 1 - Timing diagram

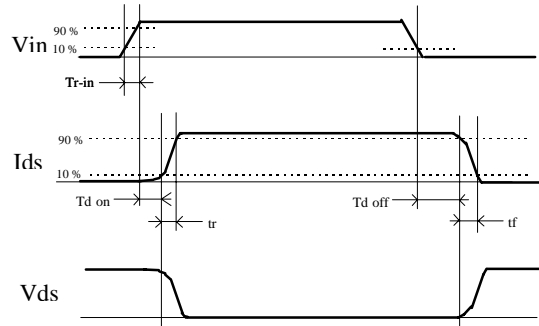

Figure 2 - IN rise time & switching time definitions

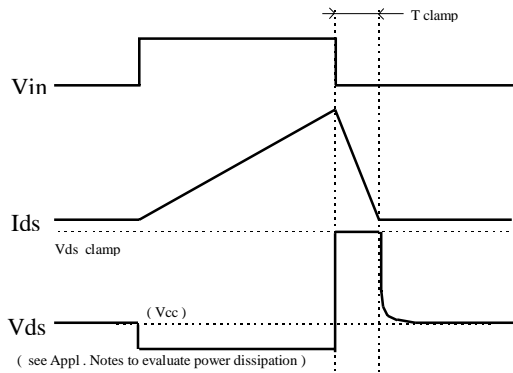

Figure 3 - Active clamp waveforms

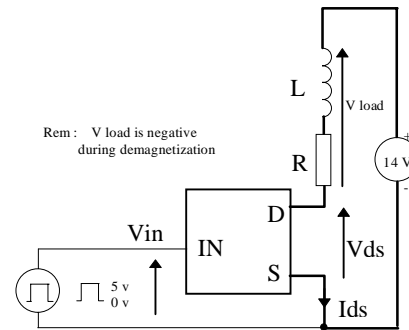

Figure 4 - Active clamp test circuit

All curves are typical values with standard footprints. Operating in the shaded area is not recommended.

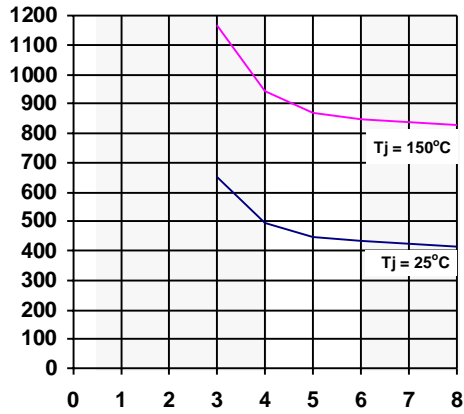

Figure 5 - Rds ON (mΩ) Vs Input Voltage (V)

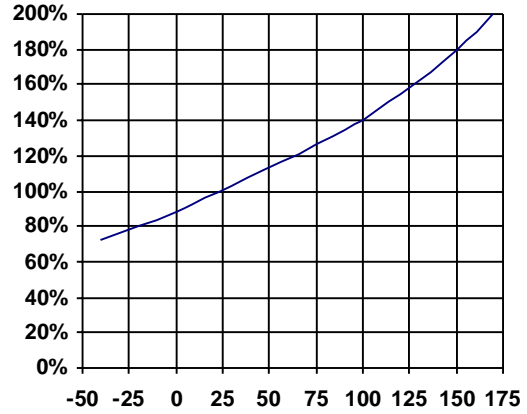

Figure 6 - Normalised Rds ON (%) Vs Tj (°C)

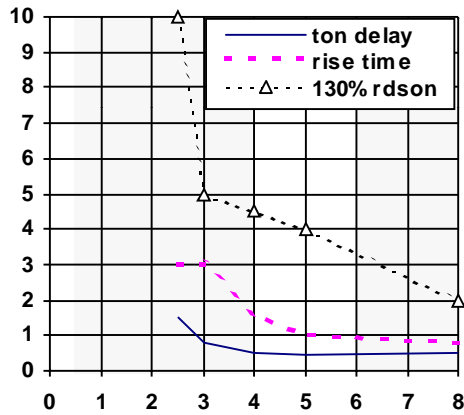

Figure 7 - Turn-ON Delay Time, Rise Time & Time to 130% final Rds(ON) (us) Vs Input Voltage (V)

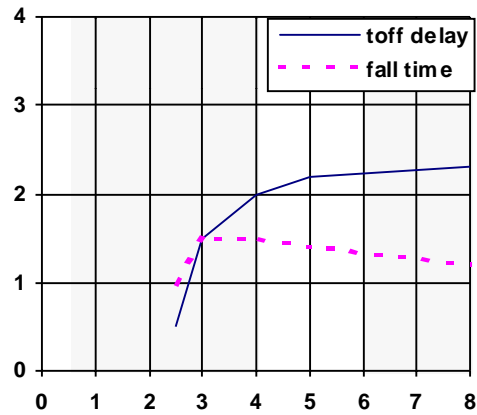

Figure 8 - Turn-OFF Delay Time & Fall Time (us) Vs Input Voltage (V)

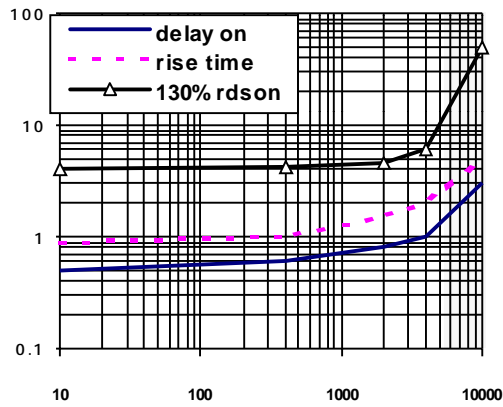

Figure 9 - Turn-ON Delay Time, Rise Time & Time to 130% final Rds(on) (us) Vs IN Resistor (Ω)

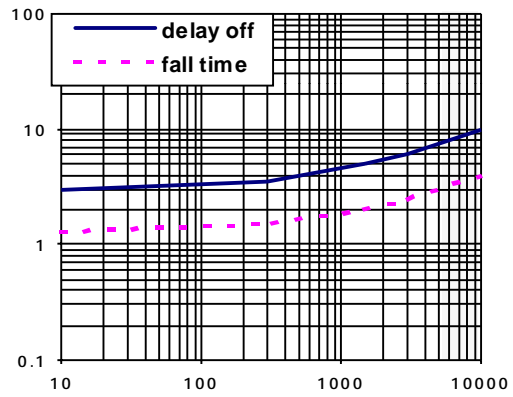

Figure 10 - Turn-OFF Delay Time & Fall Time (us) Vs IN Resistor (Ω)

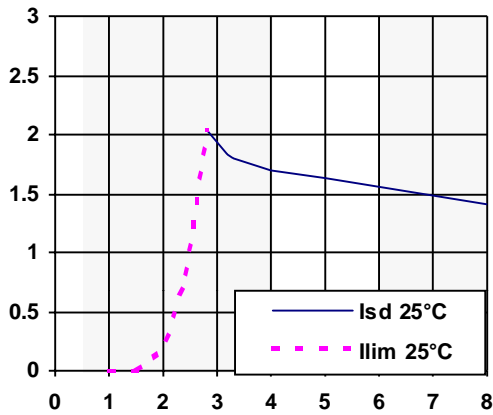

Figure 11 - Current lim. & I shutdown (A) Vs Vin (V)

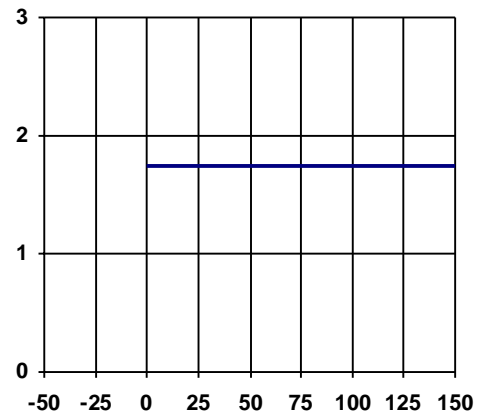

Figure 12 - I shutdown (A) Vs Temperature (°C)

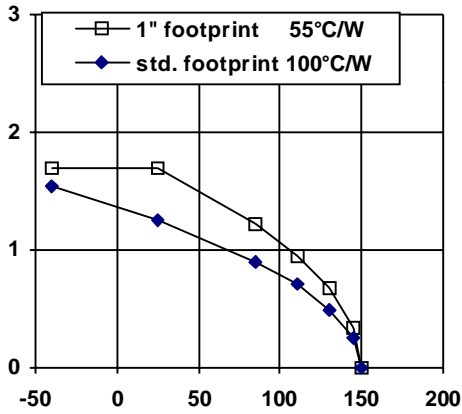

Figure 13 - Max.Cont. Ids (A) Vs Amb. Temperature (°C)

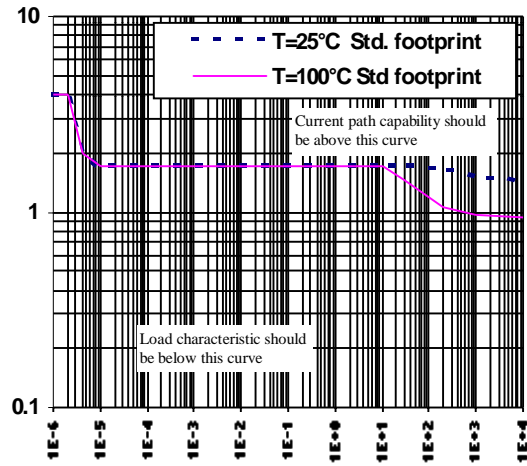

Figure 14 - Ids (A) Vs Protection Resp. Time (s)

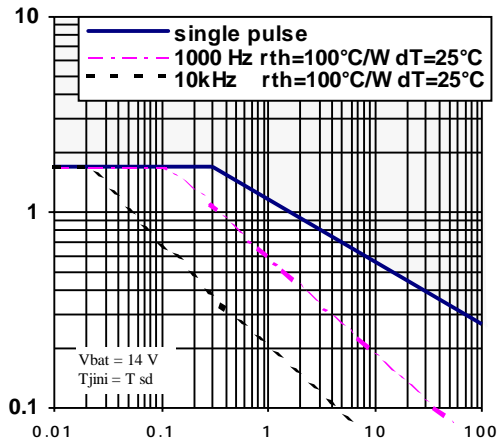

Figure 15 - Iclamp (A) Vs Inductive Load (mH)

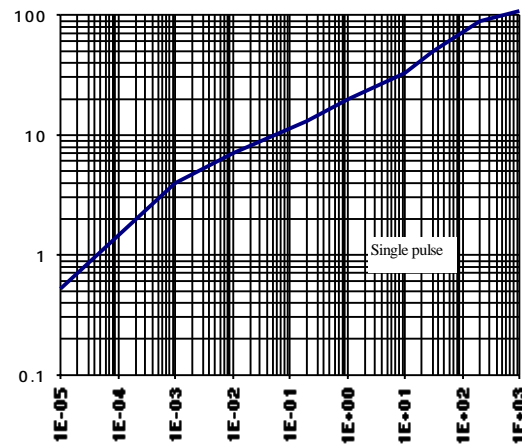

Figure 16 - Transient Thermal Imped. (°C/W) Vs Time (s)

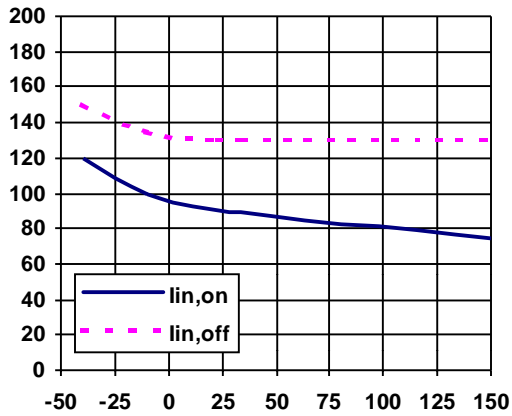

Figure 17 - Input current (μA) Vs T_j ($^{\circ}\text{C}$)

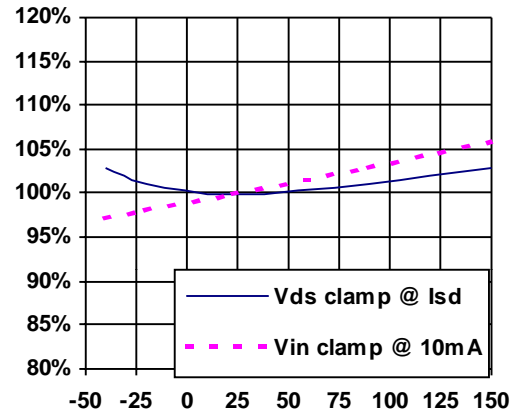

Figure 18 - V_{in} clamp and V_{clamp2} (%) Vs T_j ($^{\circ}\text{C}$)

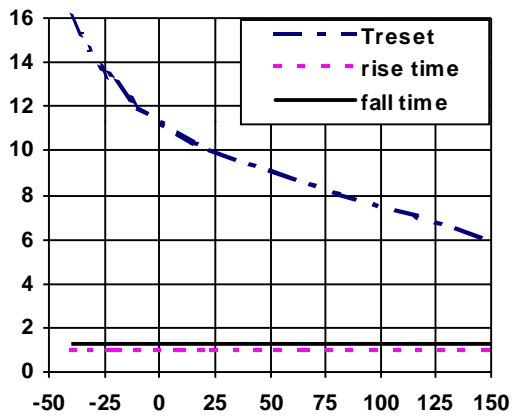
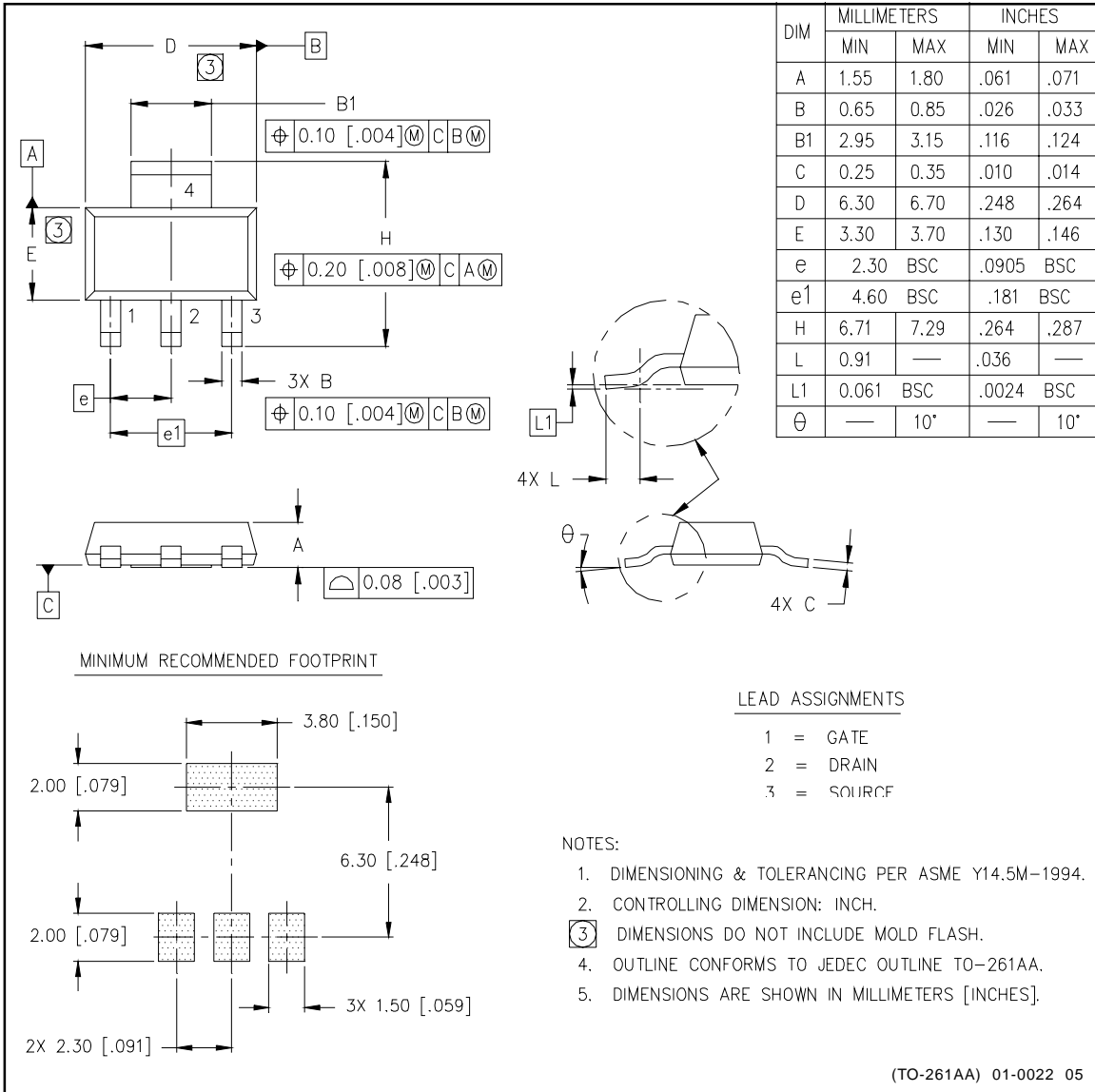

Figure 19 - Turn-on, Turn-off, and Treset (μs) Vs T_j ($^{\circ}\text{C}$)

Case Outline - SOT-223



Tape & Reel - SOT223

